

# BLOCOS STONE

## BLOCO STONE 14

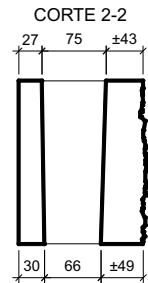
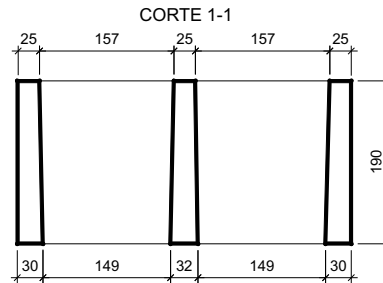
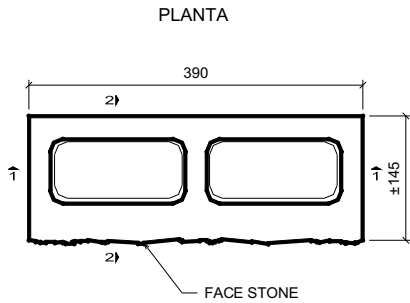

### ESPECIFICAÇÕES

CÓDIGO	Largura (mm)	Altura (mm)	Compr. (mm)	Peso Unit. (Kg/pç)	$f_{bk}$ (MPa)	Consumo (pç/m <sup>2</sup> )
ST1439	± 145	190	390	14,0	3,0	12,5
ST1419	± 145	190	190	7,3	3,0	25,0

### CORES

Este Bloco de Concreto está disponível nas cores:  
00 - Cinza Claro / 20 - Amarelo / 40 - Ocre  
60 - Vermelho / 80 - Cinza Escuro

### APLICAÇÕES

Bloco de Concreto com uma face cisalhada para Alvenarias aparentes de fachadas, interiores, muros, etc.

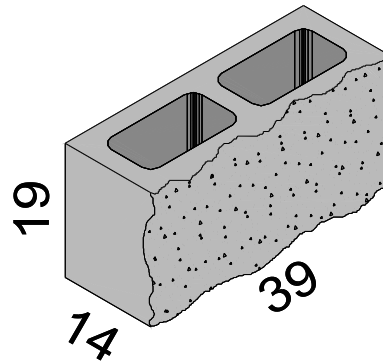

## BLOCO STONE 19

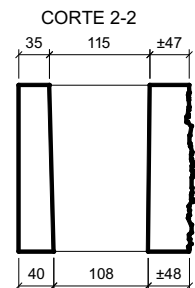
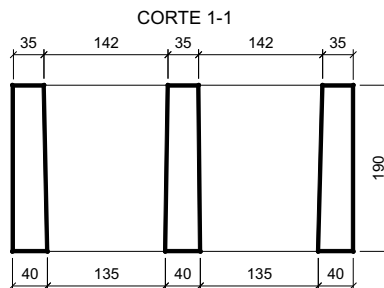
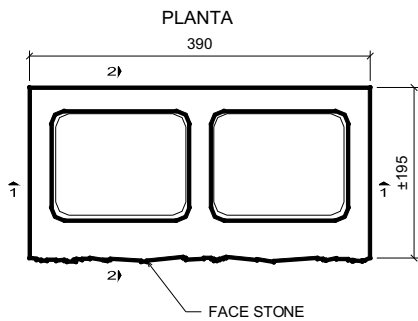

### ESPECIFICAÇÕES

CÓDIGO	Largura (mm)	Altura (mm)	Compr. (mm)	Peso Unit. (Kg/pç)	$f_{bk}$ (MPa)	Consumo (pç/m <sup>2</sup> )
ST1939	± 195	190	390	19,2	3,0	12,5
ST1919	± 195	190	190	9,6	3,0	25,0

### CORES

Este Bloco de Concreto está disponível nas cores:  
00 - Cinza Claro / 20 - Amarelo / 40 - Ocre  
60 - Vermelho / 80 - Cinza Escuro

### APLICAÇÕES

Bloco de Concreto com uma face cisalhada para Alvenarias aparentes de fachadas, interiores, muros, etc.

